

INSTRUCTION BOOK

PFAFF 30

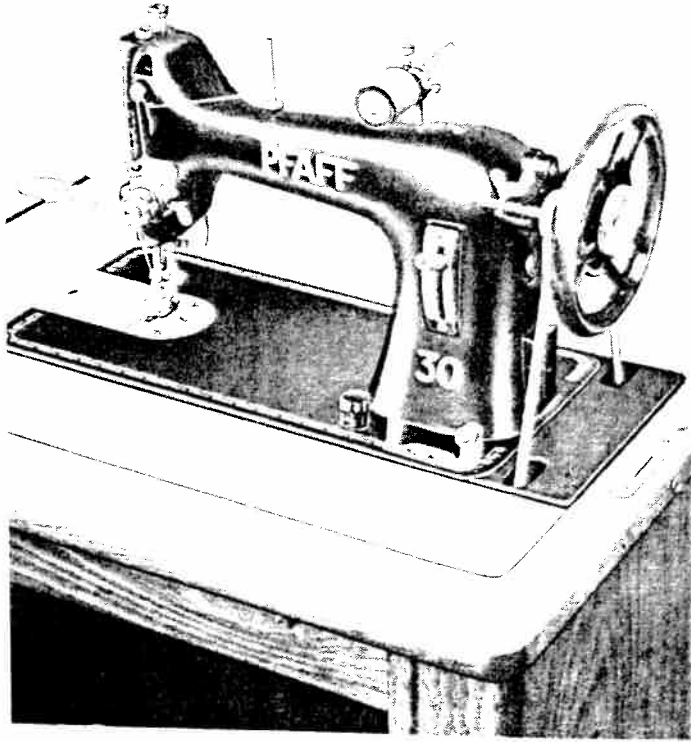

If you are a beginner, slightly rotate the balance wheel in sewing direction by hand when commencing to sew. In this way you keep it from turning in the wrong direction and causing thread jamming in the shuttle race or thread breaking.

2. Winding the Bobbin

(See Figs. 2 & 3)

1. Disengage the sewing mechanism by loosening lock nut **R**.
2. Place bobbin **7** on winder spindle **4** so that the pin on the spindle enters the slot in the bobbin.

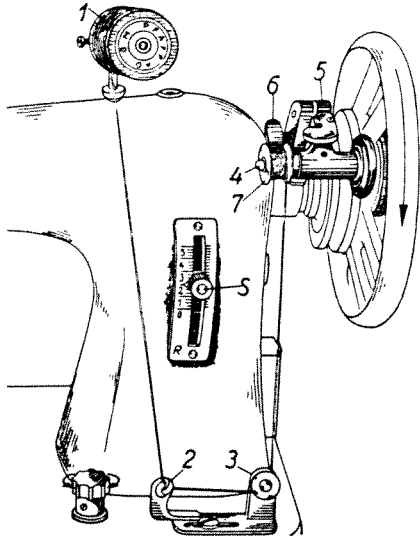

Fig. 2

3. Place spool 1 on the transverse spool pin.
4. Pass the thread from spool 1 through eyelet 2, around and between tension discs 3, and lay its moistened end on the bobbin.
5. Engage the bobbin winder by depressing lever 5. When treadling, the end of the thread will easily wind on the bobbin. The bobbin winder will stop automatically when the bobbin is filled.

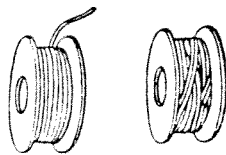

Fig. 3

Do not wind the first turns on the bobbin by hand as this would cause trouble if the bobbin is placed on the spindle the wrong way. Also, the thread may break when sewing.

3. Changing the Bobbin

1. Raise the needle bar.
2. Lift latch **A** with the forefinger of your left hand.
3. Pull out the bobbin case with thumb and forefinger, as shown in Fig. 4.
4. Release the latch and remove the empty bobbin. As long as you hold the latch open, the bobbin cannot fall out.
5. Insert the full bobbin into the bobbin case so that the thread unwinds clockwise, as shown in Fig. 5.

6. Hold the bobbin in the bobbin case, pull the thread into the slot (Fig. 6), and draw it under the tension spring (Fig. 7), leaving a loose end about 1 inch long outside the bobbin case.

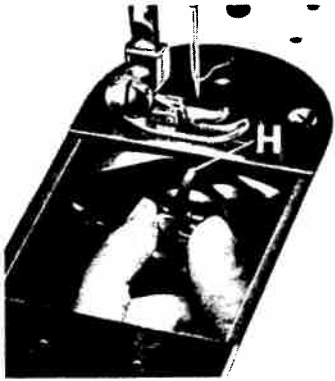

Fig. 4

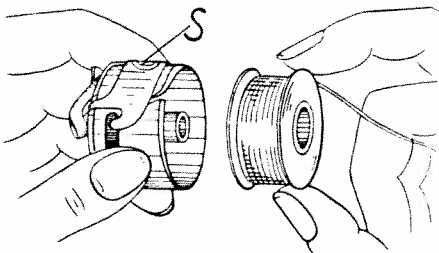

Fig. 5

7. With the needle bar raised, push the bobbin case on the center stud in the shuttle and turn it until its position finger H is opposite the position slot (Fig. 4).
8. Push the bobbin case in until it audibly snaps in place. Failure to observe this precaution may result in bobbin case or needle breakage.

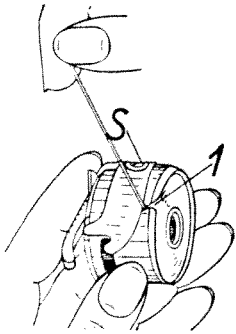

Fig. 6

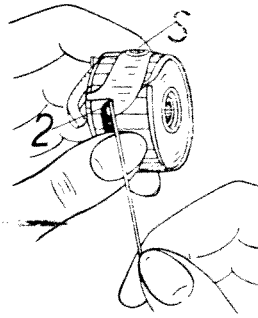

Fig. 7

4. Threading the Needle

(See Fig. 8)

The transverse spool pin ensures even unwinding of the thread and prevents thread breaking, which may occur in the case of vertical spool pins when the thread slips off the spool.

Raise the presser bar lifter and thread the needle as follows: (See Fig. 8).

Lead the thread from spool pin 1 under thread guide 2, up and around guide 3, down and between tension discs 4, through check spring 5, under thread regulator 6, through eyelet 7, from right to left through the eye

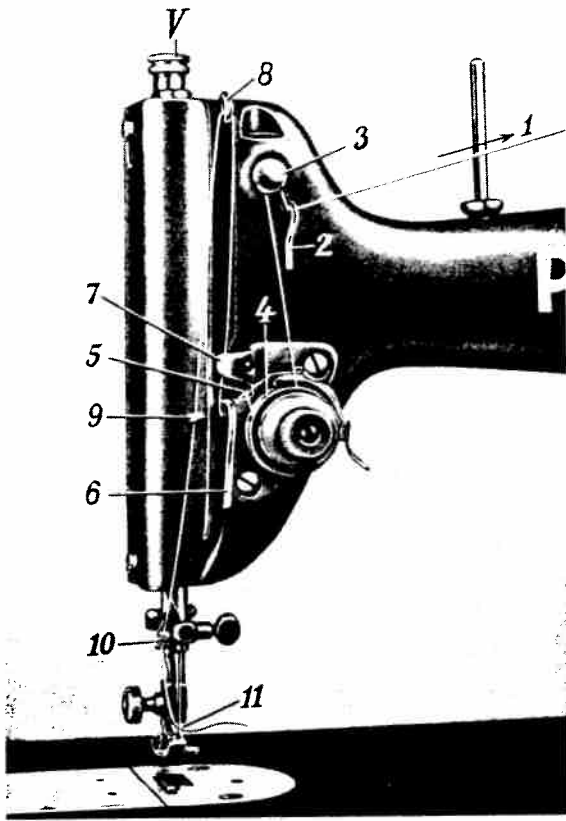

Fig. 8

R 4775

in take-up lever 8, down and through eyelet 9 on the face cover, through needle bar thread guide 10, and from left to right through needle eye 11.

Basic Rule: On all sewing machines, the needle is threaded in "long groove—short groove" direction, and inserted with its short groove facing toward the shuttle.

5. Drawing Up the Bobbin Thread

1. Hold the end of the needle thread.
2. Turn the balance wheel toward you until the bobbin thread comes up through the needle hole in a loop (Fig. 9).
3. Lay both threads back under the presser foot (Fig. 10).

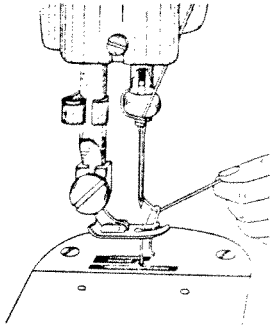

Fig. 9

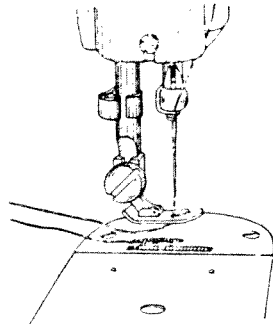

Fig. 10

Basic Rule: Always make sure the take-up lever is in its highest position when beginning or ending a seam. Failure to observe this precaution may cause thread jamming or unthreading of the needle. If observed, it is not necessary to hold the threads when beginning to sew.

6. Regulating the Thread Tensions

The tension on the needle thread is increased by turning tension nut **M** (Fig. 11) to the right, and decreased by turning it to the left. Numbers and marks stamped on the tension regulator cup greatly help in restoring the correct tension for any particular sewing job.

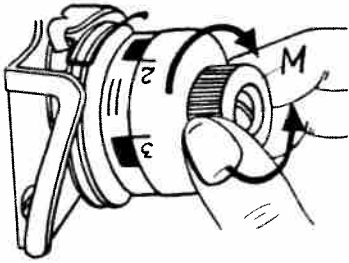

Fig. 11

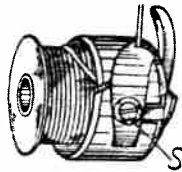

Fig. 12

The bobbin thread tension is regulated by means of a small screw driver. The tension is increased by turning screw **S** (Fig. 12) clockwise, and decreased by turning it counter-clockwise.

To obtain a perfect seam, observe the following rules:
The needle and bobbin threads should be locked in the center of the fabric, as shown in Fig. 13.

The tension should be regulated in accordance with the material to be sewn and should be such that the stitches will be tightly set and lie in a straight line.

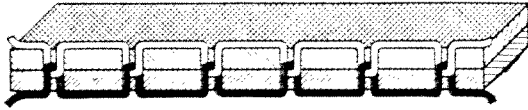

Fig. 13

The grade of thread used plays an important part in meeting these requirements.

Sheer fabrics require a thin and soft thread while elastic materials call for a resilient thread, such as silk, etc., in order to prevent the seams from breaking when subjected to strain.

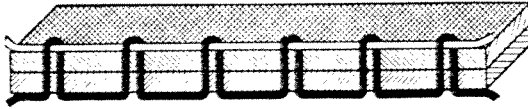

Fig. 14

In regulating the thread tensions you have to have a little experience before you can tell which tension needs adjustment.

In Fig. 14 either the upper tension may be too tight or the lower tension too loose.

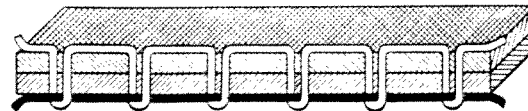

Fig. 15

In Fig. 15 the tension on the needle thread may be too weak or the lower thread tension too tight.

You will have to decide in every individual case if either the upper or the lower tension requires adjustment, particularly when the thread forms small knots or kinks on top or bottom of the fabric.

The upper tension can be adjusted only when the presser bar is lowered because it will automatically release the tension when raised.

7. Choosing the Proper Needle

The Pfaff 30 uses System 705 needles in sizes appropriate to the thread and fabric weights to be processed. Select the correct needle from the Chart on the opposite page.

For dense and thoroughly dressed materials it is advisable to select a needle one size larger than indicated in the Chart.

Although a medium size needle is adequate for ordinary sewing operations, it is recommended to use as thin a needle as possible for lightweight fabrics in order to avoid ugly needle holes in the material.

When using a thin needle with a thick thread or a thin thread in a thick needle, skipping of stitches or thread breaking may occur as a result.

Never use rusty needles since the neat appearance of the finished seam and the prevention of thread breaking greatly depend on the smooth finish of the needle.

8. Needle and Thread Chart

Types of Fabrics	Mercerized Cotton	Silk	Needle Size
Fine Fabrics such as georgette, chiffon, batiste, voile, lawn, silk.	80 to 100	0 to 000 twist	60 or 70
Lightweight Fabrics such as dress silks and cottons, sheer woolens, shirting, draperies.	70 to 80	A & B twist	80
Medium Fabrics such as lightweight woolens, madras, muslin, brocades, heavy silks and rayon, gabardine.	50 to 70	B & C twist	90
Heavy Fabrics such as coating, denim, corduroy, slipcover fabrics, bed tickings, lightweight canvas.	40 to 50	C & D twist	100
Very Heavy Fabrics such as heavy tickings, canvas, overcoating, sailcloth, upholstery.	24 to 40	E twist	90 to 110
Synthetics, Rayon, Acetate including nylon, orlon, dacron, plastics, etc.	Determined by weight of fabric 40 to 50	Determined by thread size 60 to 80	

9. Changing the Needle

(See Fig. 16)

1. Raise the needle bar to its highest position.
2. Loosen needle clamp screw **N**.
3. Pull out the needle with your left hand.
4. Insert the new needle with the flat side of its shank facing toward the needle bar and push it up as far as it will go.
5. Tighten needle clamp screw **N**.

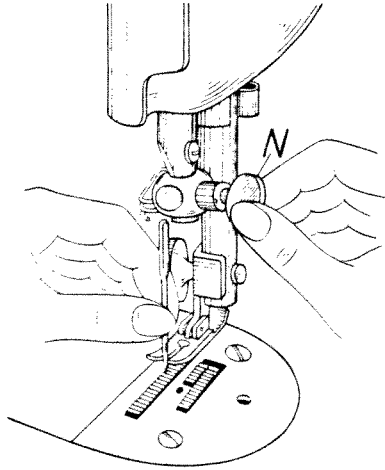

Fig. 16

10. Setting the Length of Stitch

The stitch length is regulated by moving the stitch regulator lever up or down and can be limited for forward and reverse sewing by tightening thumb nut **S** (Fig. 2).

The numerals on the left of the stitch regulator scale indicate the length of stitch in millimeters (ranging from 5 to 25 stitches per inch).

When moving the stitch regulator lever up beyond the zero mark, the machine will sew forward. For backtacking, the stitch regulator lever is to be set on **R** (for reverse).

The stitch length may be regulated when sewing. When the stitch regulator lever is set at zero, the machine will not feed at all. This position is used for embroidering and darning.

Reverse feeding should be used only for tying off the end of a seam (backtacking).

11. Regulating the Pressure on the Material

It greatly depends on the amount of pressure which is exerted by the presser foot whether the work will feed smoothly and evenly or if staggering stitches and feed markings on the underside of the fabric will occur.

Turning pressure regulating screw **V** (Fig. 8) inwardly will increase the pressure for heavier materials; turning it outwardly will ease the pressure for lightweight fabrics.

When stitching delicate and flimsy materials, it is recommended to place a piece of tissue paper under the material which will protect its underside and prevent puckering and can be readily pulled away after the sewing.

12. Cleaning the Shuttle Race

The Pfaff 30 is fitted with a central bobbin shuttle. The shuttle moves freely in the divided shuttle race and is oscillated back and forth by a shuttle driver. It has to be removed for cleaning and when thread should jam in the shuttle race.

For this purpose proceed as follows:

1. Loosen wing nut **a** and swing away race cover **R** so that shuttle **G** becomes accessible in the race.
2. Turn the balance wheel until the shuttle is at the extreme right.
3. Remove the shuttle by gripping its center stud **c** with thumb and forefinger of your left hand.

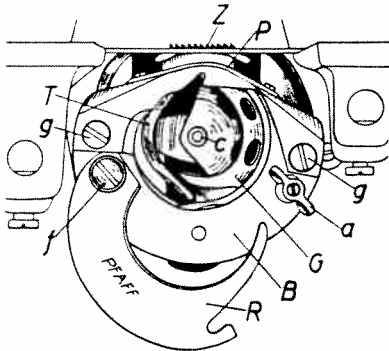

Fig. 17

Cautiously remove pieces of loose thread with a stiletto, rinse the shuttle race with cleaning fluid (kerosene), and apply sewing machine oil.

To replace the shuttle, insert it into the shuttle race from below, fitting it into the position from which it was removed. Swing cover **R** back into place and tighten wing nut **a** securely so that it will not get loose when sewing.

Complete disassembling of the shuttle race will become necessary from time to time when lint and dust have accumulated in it.

13. Dropping the Feed Dog

The Pfaff 30 has a feed dog which can be dropped for embroidering and darning. To lower the feed dog, turn clockwise the knob (Fig. 2) which is located on the bed plate in front of the arm standard. It is raised to sewing position by turning this knob counter-clockwise.

Although it is not absolutely necessary to set the stitch regulator lever at "O" for embroidering and darning, it is advisable to do so in order to ensure smoother and lighter running of the machine.

14. Using the Attachments

All ordinary sewing jobs are done exclusively with the hinged presser foot No. 43927 which is attached to the presser bar of the machine.

We have noted repeatedly that many housewives use this presser foot also for edge stitching, quilting, felling and hemming, and that the attachments which are destined for these operations are left idle in the attachment kit.

This is wrong because these special presser feet produce seams whose neat appearance is superior to any seam sewn free-hand.

Therefore you should not shun the trouble of exchanging the presser foot whenever you want to do a special sewing job for which a special attachment has been provided.

15. The Edge Stitcher with Quilting Gauge
No. 25553

This sewing foot is indispensable for sewing close to the edge of the material.

For this operation the quilting gauge is to be swung upward or removed altogether. In its place, edge guide No. 25820 is screwed onto the bed plate, as shown in Fig. 18.

The distance between the edge of the fabric and the first line of stitching, as well as between subsequent seams, can be adjusted at the edge guide as desired.

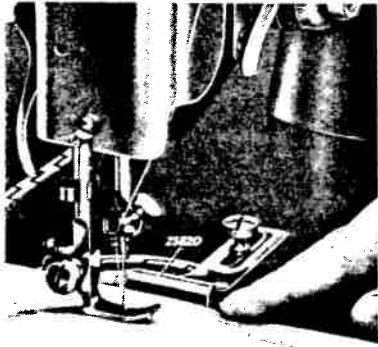

Fig. 18 R 4777

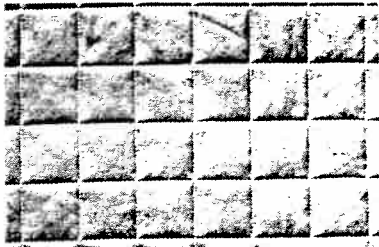

Fig. 19

R 4816

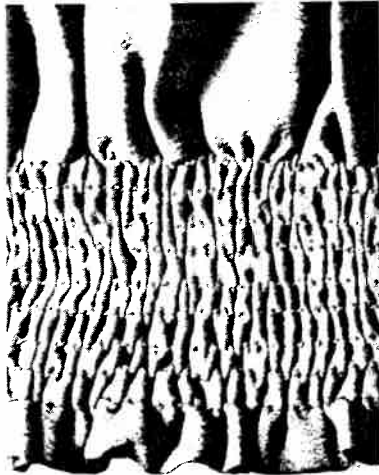

Fig. 20

R 4812

The quilting gauge No. 25811 is a valuable help in producing absolutely parallel seams and in quilting tea cosies and children's quilts, and is indispensable for sewing blouses, children's dresses and similar articles with elastic thread. (Figs. 19 & 20).

The gauge is to be set at the desired distance between seams and its finger guided along the preceding seam. (Fig. 21).



Fig. 21 R 4778

16. The Hemmer Feet No. 25576 or No. 25579

Hemming used to be very time-consuming previously when housewives had to do it by hand.

Hems in table and bed linen, aprons or lingerie which are either too wide or irregular in width spoil the appearance of the finished article.

Hemming is greatly facilitated by the hemmer feet which are standard with each machine and have slots $\frac{3}{32}$ " and $\frac{5}{32}$ " wide. They are so easy to handle that we urge you to use them for your hemming work.

The only difficulty encountered by beginners lies in commencing the hem.

Begin by inserting the edge of the fabric, preferably cut on the straight of the goods, into the scroll of the hemmer while the latter is raised.

To facilitate the insertion of the material either clip off the corner or fold the hem about 1 inch long, insert the fabric into the hemmer from the rear, and pull it back so as to bring its corner under the needle. In this way a neat and straight corner will be obtained.



Fig. 22

R 4779

Hold the edge of the fabric between thumb and forefinger of your right hand and feed just enough material into the hemmer foot to fill out the scroll.

The bulk of the material is pushed on with the left hand as the hem is sewn. This helps in evenly feeding the fabric into the hemmer.

To avoid ugly corners at the end of the hem, retard the feeding of the material shortly before the hem is finished by slightly pressing the fabric against the needle plate in front of the short hemmer toe. (Fig. 22).

17. The Felling Foot No. 25594

Lap seams are used for durably joining two pieces of fabric and will be employed to advantage in sewing light clothing, aprons and the like.

To make a lap seam on a single-needle sewing machine requires two operations.

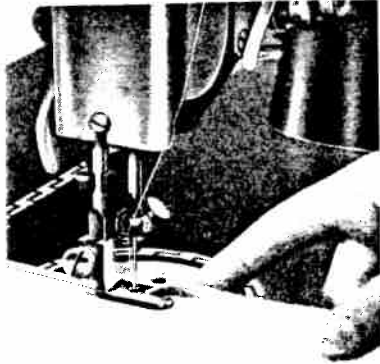

Fig. 23

R 4780

Lay both plies together so that the face sides are opposed and the top ply is short of the bottom ply by about $\frac{5}{32}$ of an inch.

Then, similar to feeding the material into the hemmer, both plies are inserted into the felling foot with the right hand.

Make sure that only the under material will be folded over the top piece and sewn on evenly. If too much fabric is fed into the felling foot, the top ply may be folded also and spoil the neat appearance of the lap seam.

The left hand passes on the bulk of the fabric and positions the top piece so that an even margin of $\frac{5}{32}$ inch is ensured. (Fig. 23).

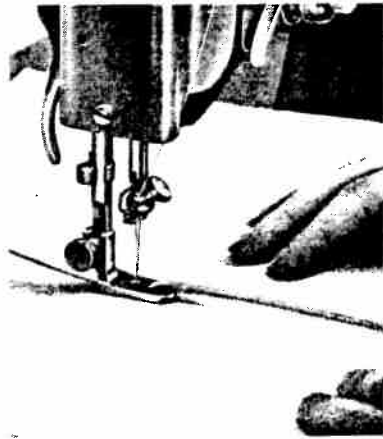

Fig. 24

R 4781

Having completed the first seam, open out the plies and smooth the seam.

Then insert the seam ridge into the felling foot and stitch it down to the left. (Fig. 24).

The lap seam thus made is exceedingly durable and looks very neat. Neither ply can creep ahead of the other in this operation.

18. Embroidering and Darning

Remove the presser foot and lower the feed dog.

Lower the presser bar lifter to engage the tension disc. To prevent the presser bar from interfering with the movement of the work, suspend it from the face plate by slipping the lower end of darning hook **S** (Fig. 2) over the presser foot set screw, raising the presser bar and inserting the top end of the hook into the hole in the face plate.

Place the work in an embroidery hoop which is available in different sizes at every Pfaff dealer.

Lightweight fabrics are darned by placing them in the hoop and setting the machine as instructed above.

Although skilled sewers will do without it, the Pfaff Darning Attachment No. 46270 is a great help in dependably and quickly darning the many things that need mending in a home.

This attachment which can be obtained from our dealers presses the material against the needle plate before the needle reaches the goods and holds the fabric down until the needle has risen clear of the material.

In this way, flagging of the material and bending of the needle with the attendant needle breakage are effectively eliminated.

Heavyweight fabrics need not be placed in a hoop if the Darning Attachment is applied.

Note that the presser bar has to be suspended by means of hook **S** also when using the Darning Attachment. (Fig. 25).

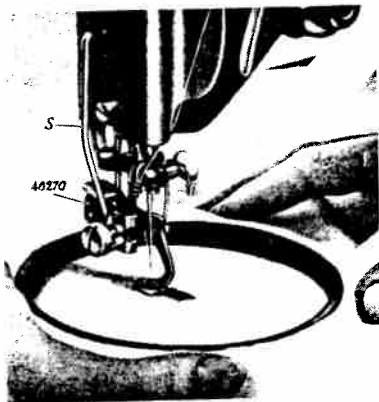

Fig. 25

R 4782

For darning, use a soft No. 40–80 machine darning thread in a color matching that of the material to be darned.

Ordinary sewing thread is twisted too much and tends to make the darn too stiff and conspicuous.

Remember that "a stitch in time saves nine" and reinforce spots that have worn thin in lightweight materials with short stitches which are made with the machine running at high speed. Holes in heavier fabrics are mended by underlaying a piece of thin fabric in a matching color.

Three-corner tears and rips are darned by taking close stitches length and crosswise. (Fig. 26).

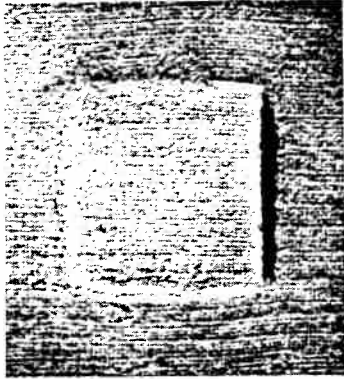

Fig. 26

In small or medium holes, cut out the defective material, following the fabric grain. First stitch back and forth across the hole from one side to the other with the machine running at high speed (Fig. 27). Then follow up with smallest stitches sewn crosswise to the first darning.

Larger holes are mended by inserting patches of self-material. Cut the patch to fit the squared hole exactly and attach it to the material by stitching back and forth across each edge of the patch.

For very large holes, the patches are cut larger than the hole and stitched to the material in the usual manner.

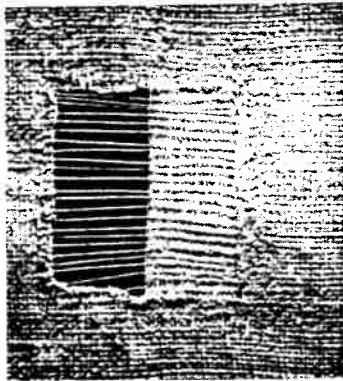

Fig. 27

19. The Feed Cover Plate No. 25997

For embroidering and darning it is advisable to slip the small cover plate over the machine feed, even when the feed dog is dropped.

This will facilitate the guiding of the fabric and increase the tension of the material in the hoop.

The cover plate can be easily slipped on without removing the needle.

To do this, open the bed plate slide, slip hook **a** of the plate into hole **b** in the needle plate as shown in Fig. 28, and turn the plate over so that it covers the machine feed. (Fig. 29).

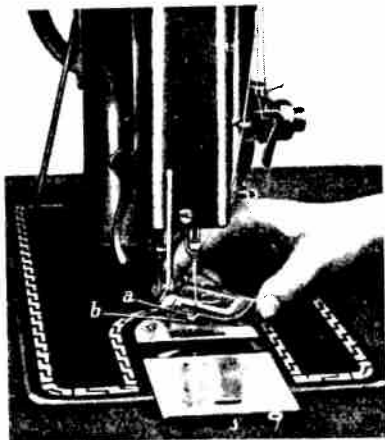

Fig. 28

R 4487

Slightly press down the cover plate and push the bed plate slide **T** back over the other two hooks **c** and **c** of the cover plate to hold it in place. (Fig. 29).

20. Care and Maintenance

Regular and proper cleaning and oiling will increase the service life of your machine.

Apply oil only to the oiling points marked with arrow in Figs. 30, 31 and 32.

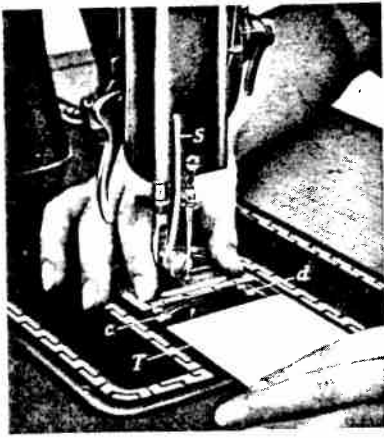

Fig. 29

R 4488

Excessive oiling will result in soiling of the work.

Lubricate your machine only with a first-rate sewing machine oil which you can obtain from your sewing machine dealer.

Remove the sewlight and the face plate and put a drop of oil into the hinges of the take-up lever.

Oil should be applied to the bearing surfaces of all parts which are in movable contact. Your machine will repay your trouble in keeping it clean and well lubricated by easy running and perfect performance.

The lint which accumulates between feed dog and shuttle race should be removed frequently.

Take a long screw driver to remove the needle plate.

Before you start working on the machine, remove presser foot and needle so that you will not injure your fingers.

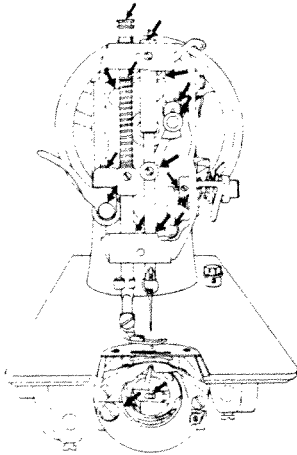

Fig. 30

Hold the screw driver perpendicularly and press it firmly into the slot of the screw to prevent burrs which are liable to hamper the feeding and injure delicate fabrics. Screws are tightened by turning them clockwise, and loosened by turning them counter-clockwise.

Place the dismantled parts and the tools on a piece of cloth which you spread out on the table. (Fig. 33).

In order to avoid damage to the lacquer coat of the machine, make it a rule never to put metal parts, including the scissors, on the bed plate.

Take a stiletto and remove the packed lint from between the tooth rows and in the recess which receives the needle plate.

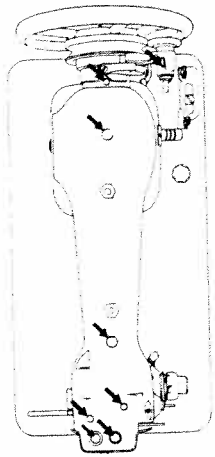

Fig. 31

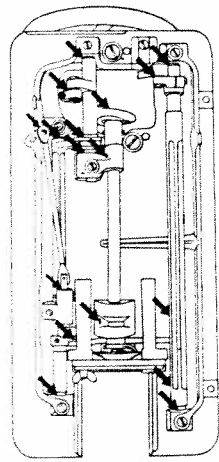

Fig. 32

A small brush will be very useful in removing dust.

Parts that come in contact with the material should be kept free of oil to prevent soiling of the work.

Do not forget to clean and lubricate the parts which are arranged underneath the bed plate of the machine.

It is particularly important that the central bobbin shuttle be well cleaned and oiled at all times to ensure perfect operation.

Make it a routine after every use to tilt the machine back and clean at least the shuttle race. (Fig. 34).

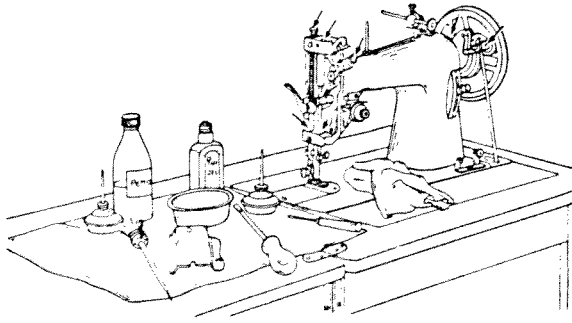

Fig. 33

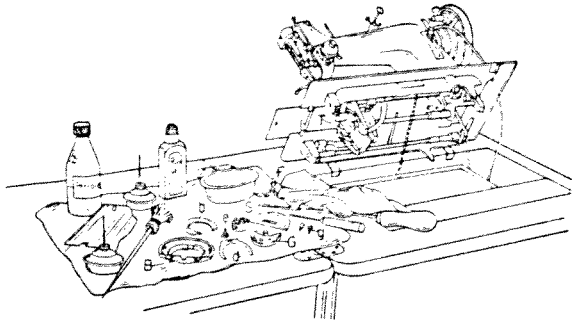

Fig. 34

Particularly new fabrics contain a dressing whose particles tend to wear the shuttle and, hence, should be removed immediately after the sewing.

Loose ends of thread may cause hard running of the mechanism.

The lacquer coat of the machine requires no special care. All that is required to preserve the gloss of the finish is to wipe the machine with a kerosene-soaked rag and then to polish it with a soft, woolen cloth.

21. Trouble Shooting

Skipping of Stitches

Cause	Remedy
Needle inserted incorrectly.	Push needle up as far as it will go and check whether long groove faces toward the left.
Wrong needle used.	The correct needle system is stamped on the bed plate slide.
Needle bent.	Insert a new needle.
Machine improperly threaded.	Check and correct threading as instructed in Chapter 4.
Needle either too thin or too thick for the thread being used.	Select correct needle from Needle and Thread Chart.

Thread Breaking

Cause	Remedy
Thread breaking may occur for any of the above reasons.	See remedies listed above.
Thread tensions too tight.	Adjust upper and lower tensions as instructed in Chapter 6.

Cause	Remedy
Poor or knotty thread used.	Use only first-rate thread or a good quality of silk.
Shuttle race without oil or thread jamming in the race.	Clean and oil the shuttle race as instructed in Chapter 12.
Thread slipped off the spool.	Place the spool of thread on the transverse rather than the vertical spool pin.

Hard Running

Cause	Remedy
Driving belt either too loose and slips, or too tight causing excessive pressure on the bearings.	Either shorten or lengthen belt by inserting a piece of belting. Cut the belt on the straight.
Shuttle race without oil or obstructed by thread.	Clean and oil shuttle race.
Mechanism clogged up by inferior oil.	Use only Pfaff sewing machine oil, never salad oil or glycerine.
Feed dog jams in the feed slot.	Unscrew both the feed dog and the needle plate and readjust properly.
Bobbin winder engaged when sewing.	Disengage bobbin winder.
Thread snarled up between balance wheel and bushing.	Remove thread with a thin needle. (If necessary, take off balance wheel).

Needle Breakage

Cause	Remedy
Needle bent and struck by point of shuttle.	Replace needle at once to prevent more damage.
Needle too thin or thread too thick.	Study Needle and Thread Chart.
Needle bent and strikes needle plate because upper tension is too tight.	Either ease upper tension or use thicker needle.
Needle bent and strikes needle plate because material is pulled.	Don't force the feeding motion, just guide the material lightly. Increase pressure on thicker material.
Bobbin case inserted incorrectly.	When inserting the bobbin case, push it in until it snaps in place audibly.

Uneven Stitches

Cause	Remedy
Tension regulated improperly.	Adjust tension as instructed in Chapter 6.
Thread too knotty, heavy or stiff.	Use only first-rate thread.
Bobbin wound unevenly.	Don't run the thread over your finger when winding the bobbin but let it run through the bobbin winder tension.

Cause	Remedy
Lack of oil in the shuttle race.	Apply one or two drops of oil.
Thread accumulated between tension discs.	Release tension and remove thread.

Noisy Running

Cause	Remedy
Accumulations of packed lint in the shuttle race.	Clean and oil shuttle race as instructed in Chapter 1.
Needle plate improperly mounted.	Unscrew needle plate and if necessary, also feed dog then readjust.
Machine insufficiently oiled or oiled with kerosene.	Clean and oil machine as instructed in Chapters 1 and 20.

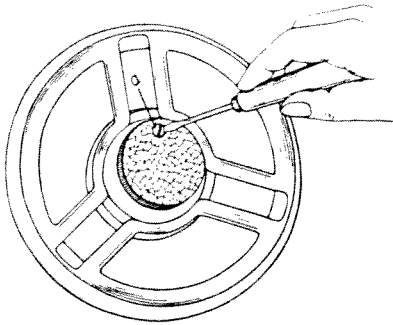

Fig. 35

Improper Feeding

Cause

Remedy

Feed dog set too low so that it does not rise sufficiently above needle plate level.

Adjust position of feed dog so that it shows a full tooth above the needle plate.

Accumulations of packed lint between tooth rows.

Take off needle plate and remove lint with a stiletto.

Insufficient pressure of the presser foot on the material.

Screw in pressure regulating screw **V**. (Chapter 11).

If machine does not feed at all, check whether feed dog has been disengaged or stitch length lever set at zero.

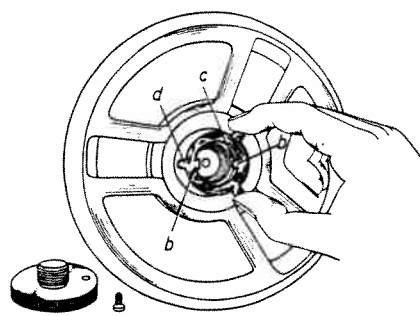

Fig. 36

Sewing Mechanism Stops

although balance wheel lock nut is properly tightened.

Cause

Remedy

Lock nut cannot be tightened sufficiently because lips of clutch washer face the wrong way. (Fig. 36).

Take out screw **a** (Fig. 35) and lock nut, turn clutch washer so that lips face toward the balance wheel and replace it. Screw in lock nut and screw **a** and, when tightening the latter, make sure that it engages behind lip **d** (Fig. 36).

Index

Chapter	Page
1. Engaging and Disengaging the Sewing Mechanism	1
2. Winding the Bobbin	2
3. Changing the Bobbin	3
4. Threading the Needle	5
5. Drawing Up the Bobbin Thread	7
6. Regulating the Thread Tensions	8
7. Choosing the Proper Needle	10
8. Needle and Thread Chart	11
9. Changing the Needle	12
10. Setting the Length of Stitch	12
11. Regulating the Pressure on the Material	13
12. Cleaning the Shuttle Race	13
13. Dropping the Feed Dog	15
14. Using the Attachments	15
15. The Edge Stitcher with Quilting Gauge No. 25553	16
16. The Hemmer No. 25579	18
17. The Felling Foot No. 25594	20
18. Embroidering and Darning	22
19. The Feed Cover Plate No. 25997	25
20. Care and Maintenance	26
21. Trouble Shooting	31



No. 3829 Wt. 0471

Printed in Germany